

Hewn's A and Better Clear Vertical Grain Cedar Siding and Paneling can be customized to fit the individual needs and specifications of your particular project. Our finely skilled craftsmen can modify nearly any part of our in-house process to create a material designed according to your specifications, and our color technicians can match any shade or tone provided to us as part of our custom sampling process.

A and Better Clear Vertical Grain Cedar, often simply referred to as CVG Cedar, is a highly prized and sought-after wood option known for its exceptional beauty and versatility.

What sets this option apart is its distinctive grain pattern, characterized by straight, closely spaced vertical lines that run primarily parallel to the length of the board. This unique grain pattern is a result of how the wood is sawn and cut, and can be showcased on both interior and exterior applications.

A and Better Clear Vertical Grain Cedar Collection

Hewn's A and Better Clear Vertical Grain Cedar Collection is designed to embody the perfect synergy of beauty and performance, showcasing the inherent elegance of nature's craftsmanship while providing enduring quality. All products can be customized, and are available in variations for both interior and exterior applications.



Clear

Corral

Daku Ban

Dark Roast

Desert Sand



Driftwood

Natural Honey

Noir

Saddle

Fifty Percent Saddle



Product Specifications: A & Better Clear Vertical Grain Cedar



Stone Grey

Weathered Grey

A & Better CVG Cedar Specifications

Material	Grade	Thickness	Standard Widths
Western Red Cedar	A & Better Clear Vertical Grain	11/16"	1×4 (3½" face) 1×6 (5½" face) 1×8 (7¼" face) 1×10 (9¼" face) 1×12 (11¼" face)
Milling	Applications	Textures	
Board to Board Tongue & Groove Shiplap Custom	Interior Paneling Exterior Siding	Brushed Smooth Light Brushed * Vertical Brushed † Resawn * Circle Sawn *	
		* Custom Option † Default on Peppercorn, Desert Sand and Mushroom	

Custom Options

Hewn's A and Better Clear Vertical Grain Cedar can be customized to fit the individual needs and specifications of your particular project. Our finely skilled craftsmen can modify nearly any part of our in-house process to create a material designed according to your specifications, and our color technicians can match any shade or tone provided to us as part of our custom sampling process.



The Cedar Advantage

Beyond its aesthetic appeal, one of the most distinctive qualities of A and Better Clear Vertical Grain Cedar is its remarkable durability and natural material resistance to decay, insects, and moisture. This makes it a popular choice for both exterior and interior applications, where Cedar's rich history as a construction material gives credence to its continued use as a premier option.

Standard Milling Profiles

Hewn's A & Better Clear Vertical Grain Exterior Cedar Siding is available in a variety of milling profiles, designed to fit the individual needs of your project. Our most common milling profiles, listed on this page, assume our standard thickness of 11/16".

Our A & Better Clear Vertical Grain Exterior Cedar Siding is milled to your requested specifications in-house, allowing for the highest level of oversight throughout the entire production process.

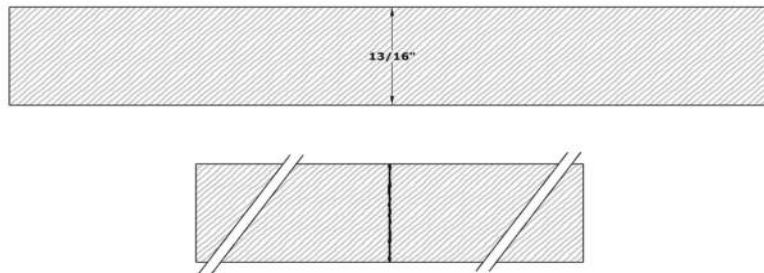

Standard Milling Profile Widths

Square Edge

1×4 (3½" face)
1×6 (5½" face)
1×8 (7¼" face)
1×10 (9¼" face)
1×12 (11¼" face)

Tongue & Groove

1×4 (3⅞" face)
1×6 (5" face)
1×8 (6 ⅝" face)
1×10 (8 ⅝" face)
1×12 (10 ⅝" face)

Shiplap

1×4 (2¾" face)
1×6 (4¾" face)
1×8 (6½" face)
1×10 (8½" face)
1×12 (10½" face)



T&G Milling Profiles

Hewn's A and Better Clear Vertical Grain Exterior Cedar Siding is sold in widths of 1×4, 1×6, 1×8, 1×10, and 1×12. T&G 1×4 and 1×6 profiles come standard with a 1/4" tongue. T&G 1×8, 1×10, and 1×12 T&G profiles require a 3/8" tongue, instead of a 1/4" tongue. Profiles for our most common widths (1×6 and 1×8) are shown below. For more profiles, please refer to our Specification Sheet. Hewn has the capability to create custom milling knives in-house. For more information on custom milling options, please contact one of our sales representatives.

1x6 T&G Milling Profiles

T&G 1x6 Tight

A&BTR CVG Cedar 1X6 T&G Tight

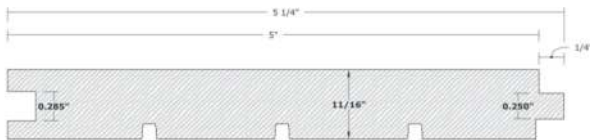

T&G 1x6 1/16" Fineline

A&BTR CVG Cedar 1X6 T&G 1/16" Fineline

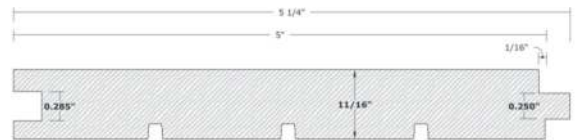

T&G 1x6 1/8" Fineline

A&BTR CVG Cedar 1X6 T&G 1/8" Fineline

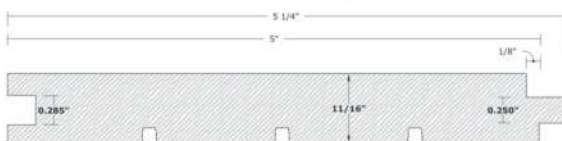

T&G 1x6 1/4" Fineline

A&BTR CVG Cedar 1X6 T&G 1/4" Fineline

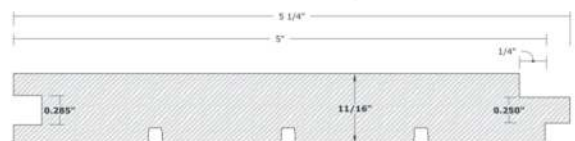



1x8 T&G Milling Profiles *

T&G 1x8 Tight

A&BTR CVG Cedar 1X8 T&G Tight

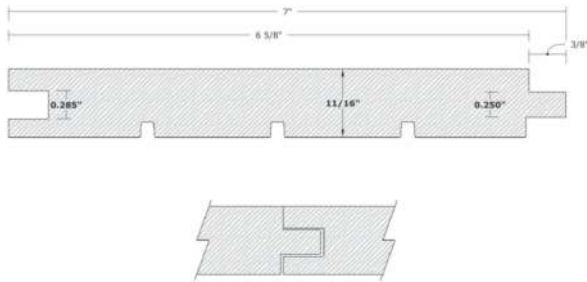

T&G 1x8 1/16" Finline

A&BTR CVG Cedar 1X8 T&G 1/16" Finline

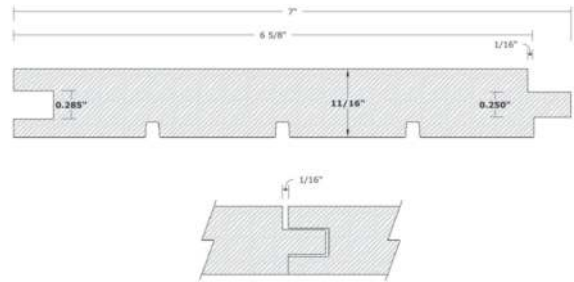

T&G 1x8 1/8" Finline

A&BTR CVG Cedar 1X8 T&G 1/8" Finline

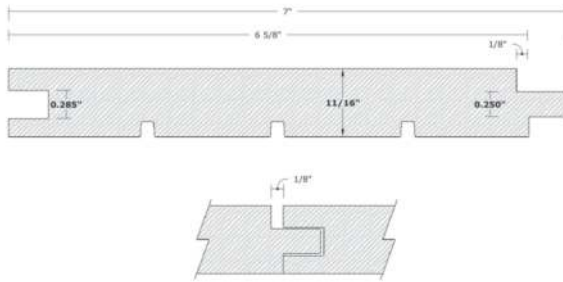

T&G 1x8 1/4" Finline

A&BTR CVG Cedar 1X8 T&G 1/4" Finline

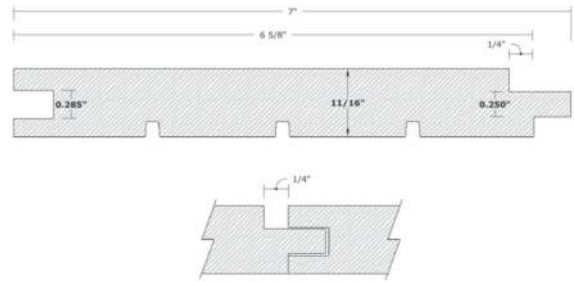

* 1x8, 1x10, and 1x12 T&G profiles require a 3/8" tongue, instead of a 1/4" tongue.



Shiplap Profiles

Hewn's A and Better Clear Vertical Grain Exterior Cedar Siding is sold in widths of 1x4, 1x6, 1x8, 1x10, and 1x12. Profiles for our most common widths (1x6 and 1x8) are shown below. For more profiles, please refer to our Specification Sheet. Hewn has the capability to create custom milling knives in-house. For more information on custom milling options, please contact one of our sales representatives.



A & Better Clear Vertical Grain Cedar - Driftwood

1x6 Shiplap Milling Profiles

Shiplap 1x6 Tight

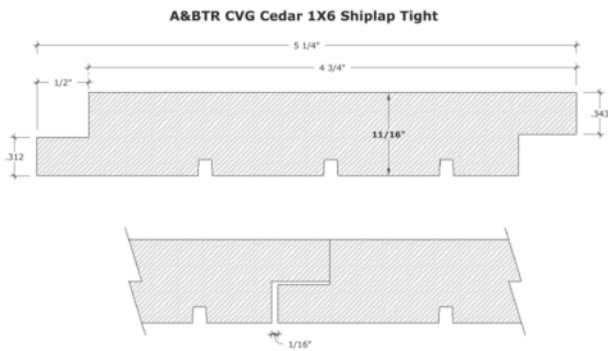

Shiplap 1x6 1/16" Finline

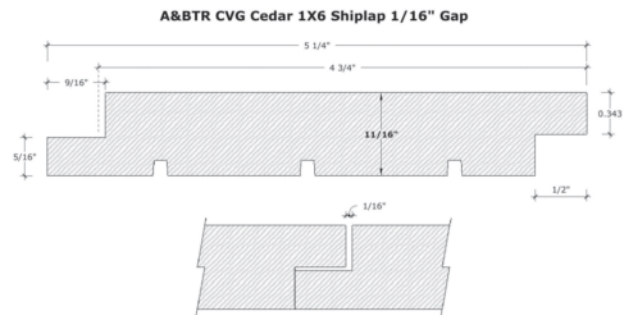

Shiplap 1x6 1/8" Finline

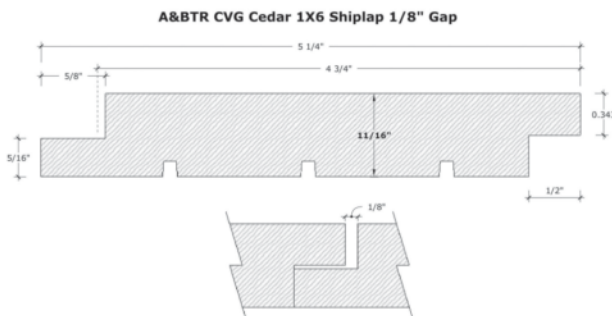

Shiplap 1x6 1/4" Finline

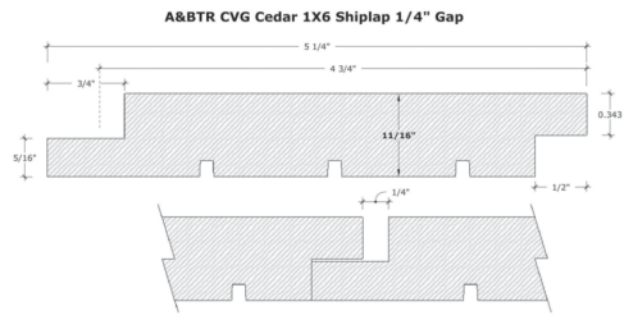



1x8 Shiplap Milling Profiles

Shiplap 1x8 Tight

A&BTR CVG Cedar 1X8 Shiplap Tight

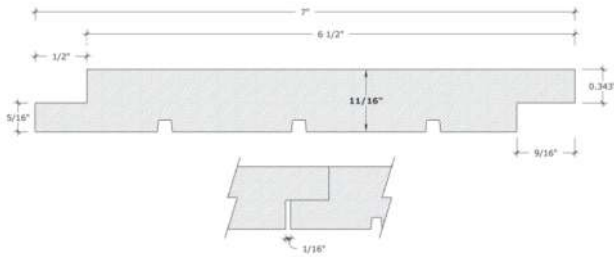

Shiplap 1x8 1/16" Fineline

A&BTR CVG Cedar 1X8 Shiplap 1/16" Gap

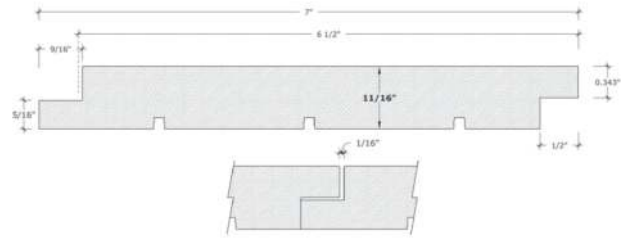

Shiplap 1x8 1/8" Fineline

A&BTR CVG Cedar 1X8 Shiplap 1/8" Gap

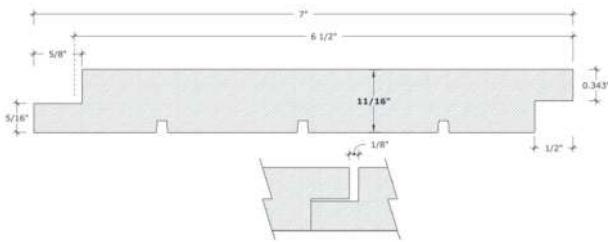

Shiplap 1x8 1/4" Fineline

A&BTR CVG Cedar 1X8 Shiplap 1/4" Gap

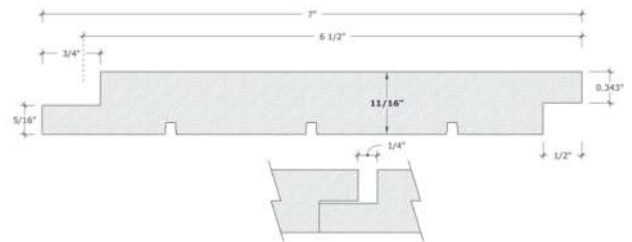

Exterior Siding Accessory Profiles

CEDAR WINDOW SILL (3-1/8" X 1-3/8")

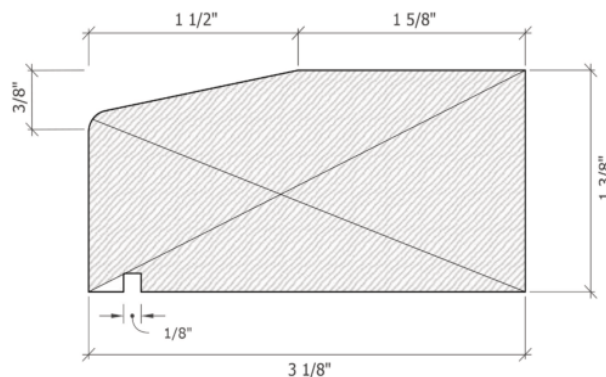

Nova Rainscreen System

Hewn has partnered with Nova USA Wood to pair their industry-leading Rainscreen Siding ecosystem with Hewn's exterior siding products, including our Class A Fire Rated siding. Our highly skilled sales associates work with you throughout the entire process, ensuring that the product you order is customized to your individual needs, and is appropriate for your intended application.

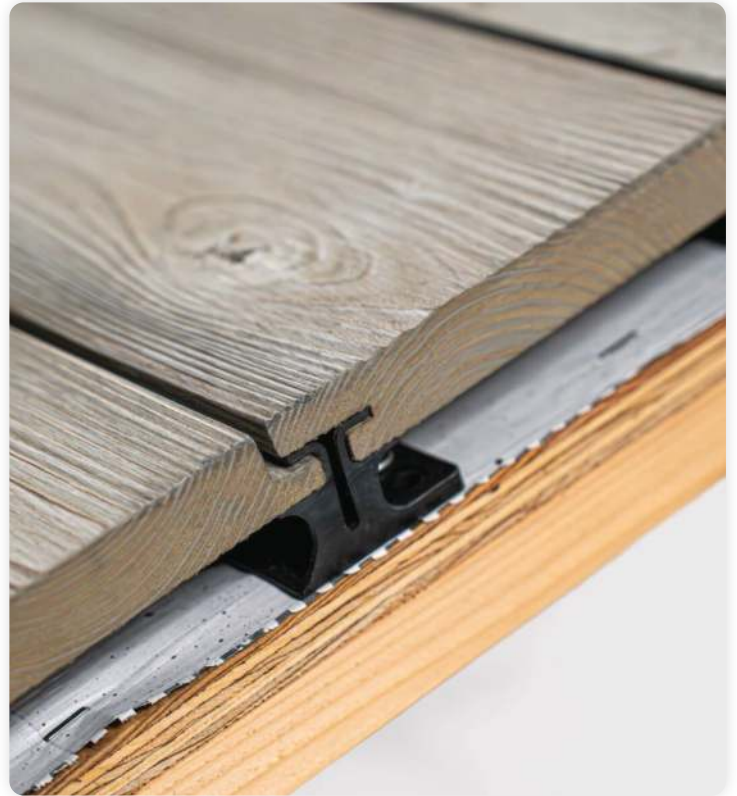

Nova Rainscreen 1x6 A&BTR CVG

A&BTR CVG 1x6 Nova Rainscreen 3/32" Gap

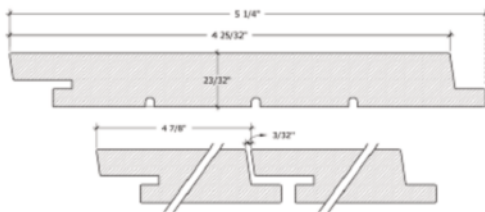

A&BTR CVG 1x6 Nova Rainscreen 1/4" Gan

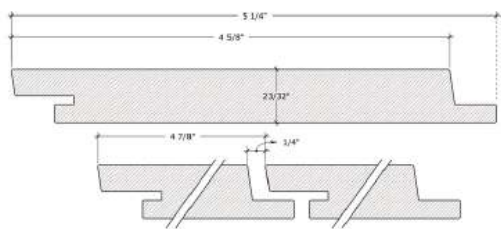

A&BTR CVG 1x6 Nova Rainscreen 1/2" Gan

