



Natural wood
Made to last

Installation Guide



Kebony Clear Passive Rainscreen

Please read these guidelines carefully, and if you have any questions, **e-mail: info@kebony.us** or **call: +1 833.795.8660**



www.kebony.us
[@kebonyusa](https://www.instagram.com/kebonyusa)

Preparing for Installation

SAFETY GUIDELINES

Installing the Kebony Clear Passive Rainscreen (PRS) system is a construction project, therefore you should wear protective clothing and safety equipment such as, but not limited to, safety glasses, gloves, long sleeves, and a mask, particularly when cutting wood.

The installer is responsible for identifying and following all building codes and construction safety practices. Kebony accepts no liability or responsibility for the improper installation of this product.

Kebony Clear PRS cladding may not be suitable for every application, and it is the sole responsibility of the installer to ensure that this profile is fit for the intended use. Because all installations are unique, it is also the installer's responsibility to determine specific requirements for each siding application.

Kebony recommends that all applications be reviewed by a licensed architect, engineer or local building official before installation.

STORAGE

Kebony should not be exposed directly to the elements prior to installation. Kebony should be kept covered with plastic tarp or other waterproof material prior to installation.

PREP

Perform all necessary preparatory work for your specific project, (e.g. building wrap, flashing, window frames, etc.)

Metal Fixture Considerations: While stainless steel fixtures are ideal, Kebony can be used with aluminum, enamelled, powder-coated or foiled fixtures without concern for discoloration. However, in some cases surface water runoff from Kebony can result in discoloration of adjacent materials. For example, it could cause black stains on zinc fixtures or polished copper.

Drainage and runoff from galvanized or iron-based fixtures onto Kebony can result in black discoloration of the wood.

RECOMMENDED TOOLS & EQUIPMENT



Electric Saw (Table, Chop etc.)

- With a fine carbide blade



Miter saw



Drill (Cordless or Corded)

- With Carbide Drill Bit for Pre-Drilling



Ladders and/or scaffolding

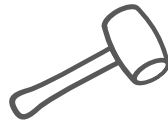

Rubber Mallet



Level

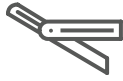

T-bevel



Hammer



Chalkline



Laser Level

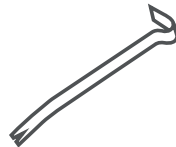

Flat pry bar



Utility Knife



Measuring Tape



Pencil

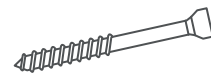

Trim Head Stainless Steel Screws
(Included with PRS clips)

GENERAL INSTALLATION GUIDELINES

The Kebony PRS system can be installed horizontally, vertically, diagonally or as a soffit.

Ground Clearance: Allow for 12" clearance above grade.

Fastener type: All 316 stainless steel screws required for use with the marine grade aluminum PRS clips are included with the PRS system. When face-fastening is necessary, use trim head stainless steel screws - all holes should be pre-drilled. Screw head size, length, and grades are to be selected by the installer based on site specifics.

Spans/Clip Spacing: A maximum 24" span between clips is supported.

Butt-jointing boards: When butt-jointing Kebony cladding, cut the end joints at 45 degree angles to form an overlapping joint (Scarf Joint). This is particularly important for vertical installation. Ensure joints meet on studs, blocking or furring strips. For vertical applications, the joint cut should slope downward from the back towards the front.

Wherever possible, use full length boards. If there is a field cut scarf joint, then the PRS clip will no longer work on those edges, so a screw has to be used.

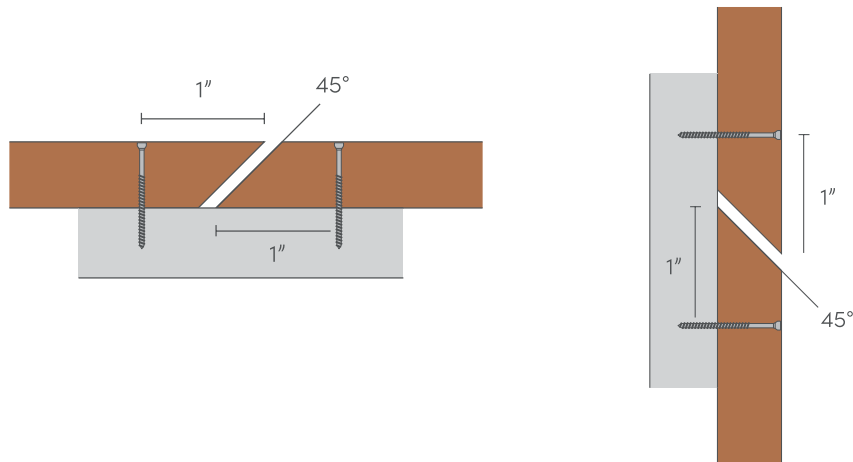

Do not pre-drill or fasten Kebony within 1" of the edge.

HORIZONTAL APPLICATIONS

The Kebony PRS System automatically creates an air gap of either 3/4" (high-profile clip) or 3/8" (low-profile clip). Be sure to choose the correct clip profile for your project.

The PRS clips should be installed directly to the studs over a suitable house underlayment or drainage wrap. Studs should be placed no more than 24" on center.

1

Begin at the bottom and work up. Set a level line across all walls using a conventional or laser level.

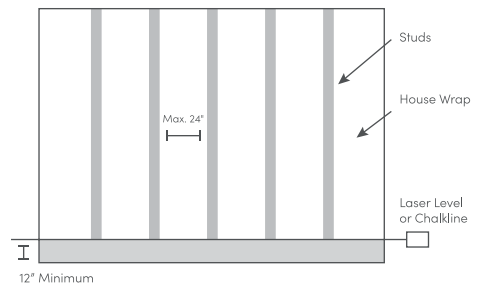

2

Place the first PRS clip on the first stud in line with the laser level or chalk line. With the screw holes facing up, install the first line of clips across the wall.

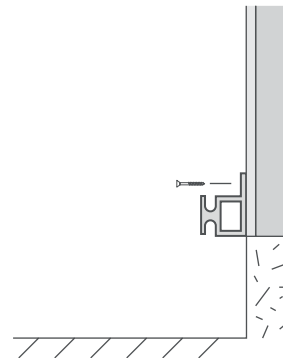

3

Measure and cut each board to length and lay the grooved edge into the clip. Securely tap it into place with a rubber mallet so that it is properly seated in the clip.

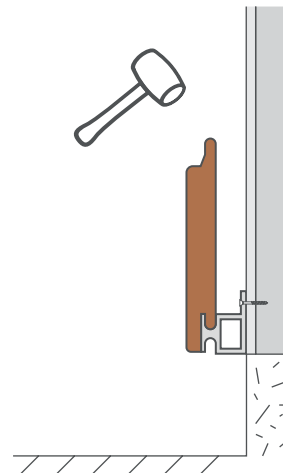

4

Secure the next set of clips by repeating step 2.

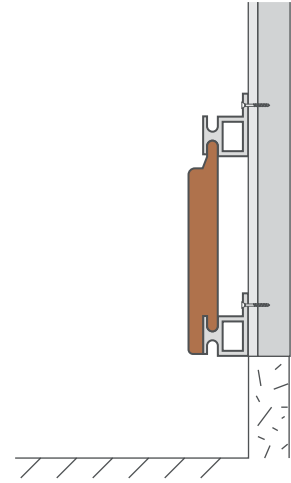

5

Repeat steps 3 & 4 and check that the boards are level every few boards.

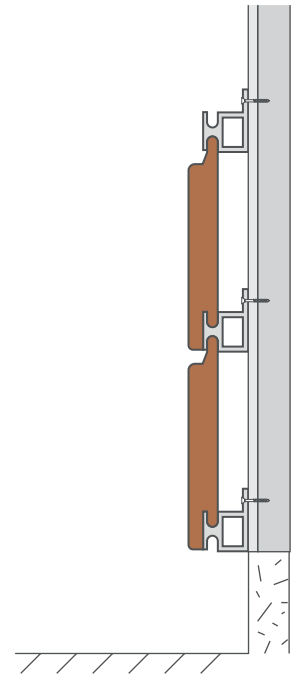

6

Top board(s) at the roofline may need to be custom cut. If the top is horizontal, the top board may need to be ripped to width and should be face fastened to blocking behind the cladding. If the roofline has a slope, multiple boards will likely have to be cut at angles on the end(s). Various tools are available to help determine the angle.

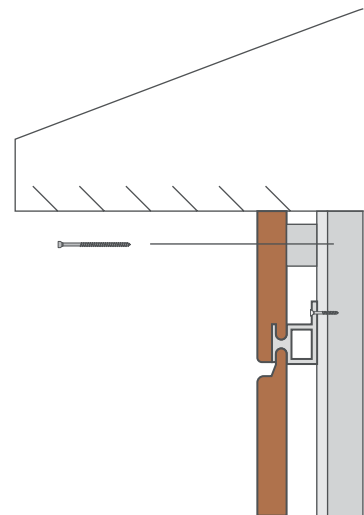

VERTICAL APPLICATIONS

The Kebony PRS system automatically creates an air gap of either 3/4" (high-profile clip) or 3/8" (low-profile clip). Be sure to choose the correct clip profile for your project.

The PRS clips should be installed directly to the studs over the suitable house underlayment or drainage wrap. Vertical installation requires horizontal studs placed no more than 24" on center.

Before installing your first board, take a moment to consider where your vertical joints will align with respect to windows and doors. This way you can plan ahead and avoid having especially narrow boards installed in those locations or at the end of your siding.

1

Use a level to ensure the first vertical board is installed plumb. With the first board, if necessary for fit, rip the board to width and face fasten the corner with blocking behind the board to account for the PRS clip. Remember to pre-drill the board at least 1" from the edge.

When face fastening Kebony, you may use the optional Starborn Pro Plug® System for Wood to hide the face fasteners.

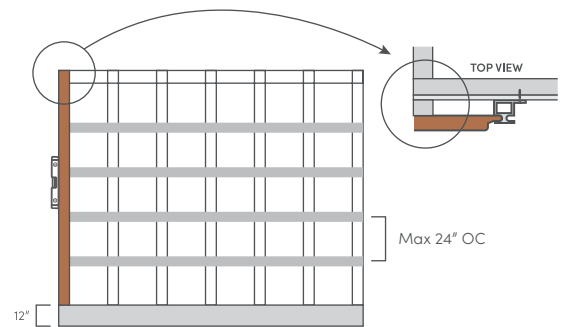

Corners details are the choice of the architect and project owner. There are many options, including, but not limited to mitered corners, corner boards, trim boards, etc.

2

Install the first column of PRS clips along the edge of the first board. Start at the bottom of the wall and move up. Secure the clip with the screw holes facing out from the edge of the board.

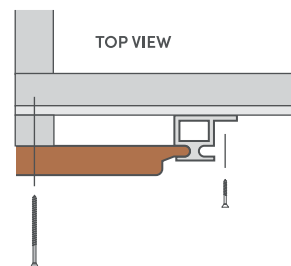

3

Measure and cut each board to length and lay the grooved edge into the clip. Securely tap it into place with a rubber mallet so that it is properly seated in the clip.

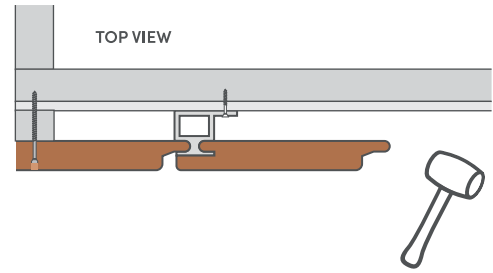

4

Repeat steps 2 & 3, checking that the boards are level every few boards.

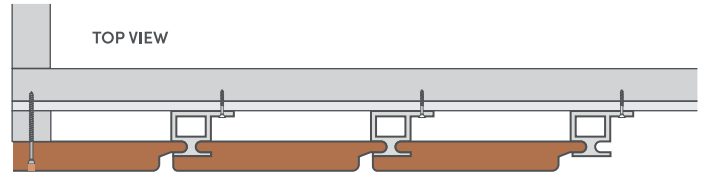

5

Top board(s) at the roofline may need to be custom cut. The end of the boards should be face fastened to blocking behind the cladding. Use stainless steel screws and pre drill hole at least 1" from the end of the board. If the roofline has a slope, multiple boards will likely have to be cut at angles on the end(s). Various tools are available to help determine the angle.

