



Select Grandis - Driftwood - Vertical Brushed

Hewn's Select Grandis is an exceptional choice for those seeking rich color, dimensional stability, and sustainable performance in their building materials. Sourced from responsibly managed plantations in South America, this fast-growing hardwood offers the warmth and depth of traditional hardwoods with superior eco-friendly credentials. Select Grandis provides remarkable durability and a naturally rich tone that brings character to both Interior Paneling and Exterior Siding applications.

Our Select Grandis features a distinctive grain pattern with warm base hues that deepen beautifully over time. This sustainable and versatile option ensures that your projects are not only visually striking but also built to last, offering an environmentally conscious alternative to slower-growing hardwood species.

Select Grandis Collection

Hewn's Select Grandis Collection is designed to showcase the natural warmth and character of this unique species, featuring colors and finishes that excel in both contemporary and traditional applications.

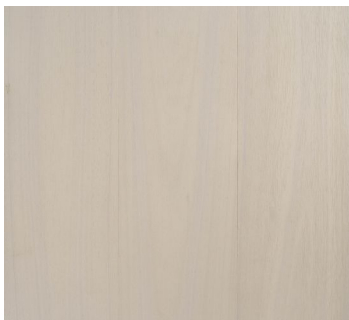

Bone White
Brushed

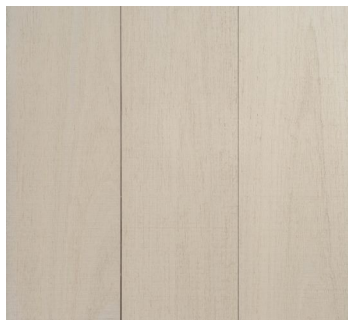

Bone White
Resawn



Bone White
Vertical Brushed

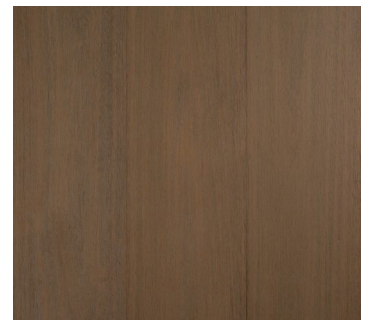

Burlap
Brushed



Burlap
Resawn

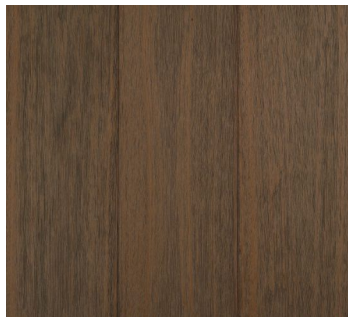

Burlap
Vertical Brushed

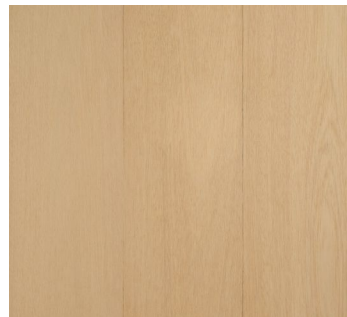

Chanterelle
Brushed



Chanterelle
Resawn



Chanterelle
Vertical Brushed

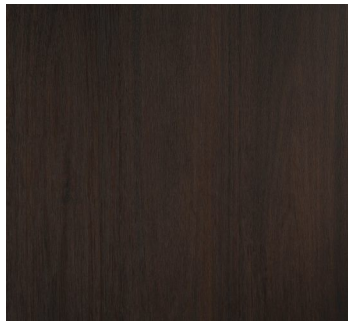

Dark Roast
Brushed

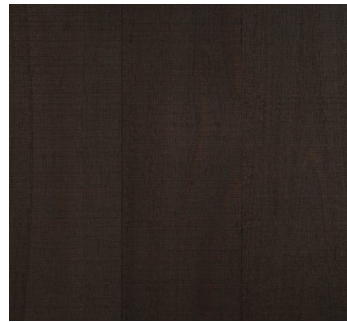

Dark Roast
Resawn



Dark Roast
Vertical Brushed

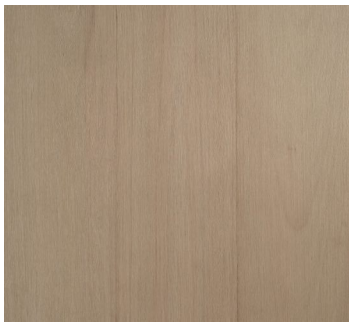

Desert Sand
Brushed

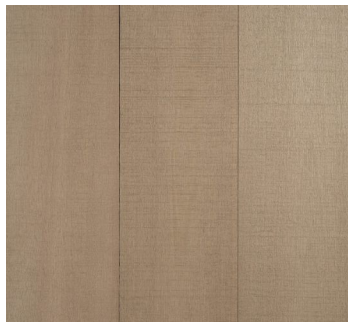

Desert Sand
Resawn

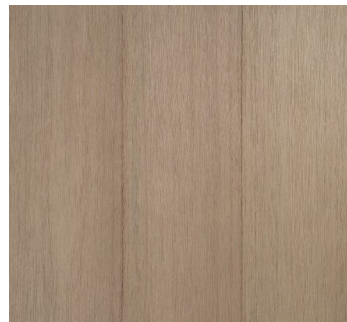

Desert Sand
Vertical Brushed

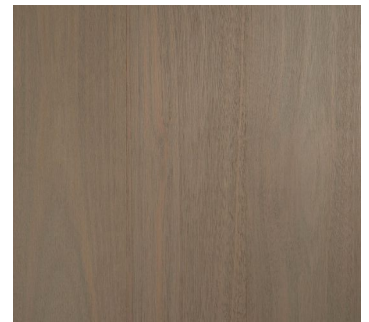

Driftwood
Brushed



Driftwood
Resawn

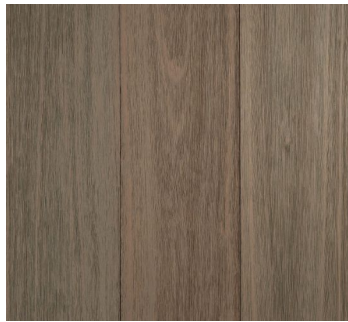

Driftwood
Vertical Brushed



Mushroom
Brushed



Mushroom
Resawn



Mushroom
Vertical Brushed

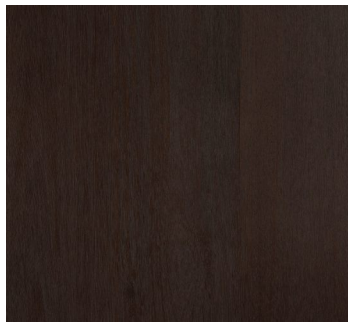

Noir
Brushed

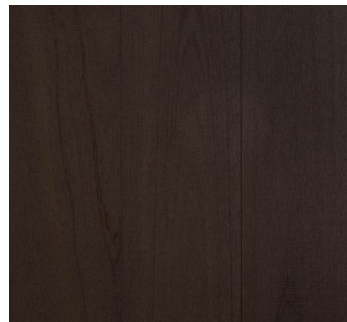

Noir
Resawn

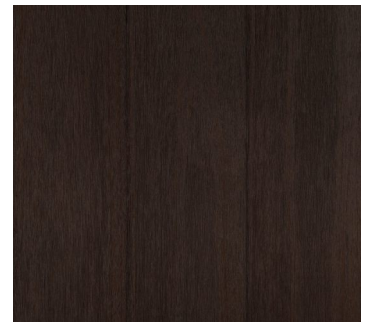

Noir
Vertical Brushed



Peppercorn
Brushed



Peppercorn
Resawn

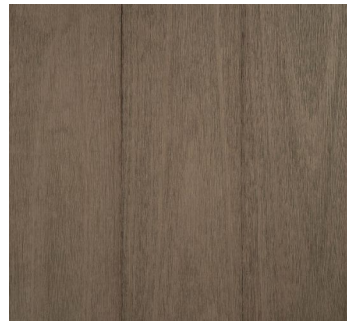

Peppercorn
Vertical Brushed



Pistachio Shell
Brushed

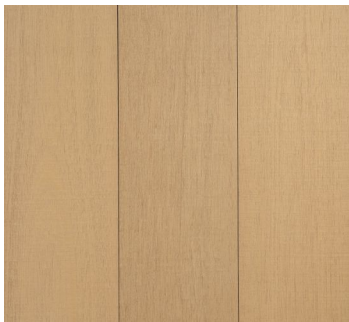

Pistachio Shell
Resawn

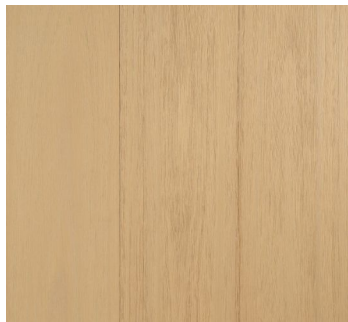

Pistachio Shell
Vertical Brushed

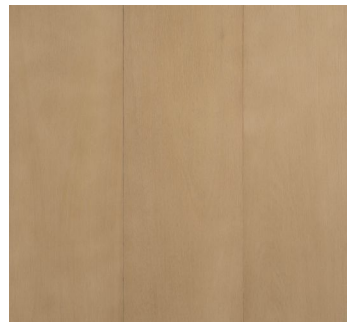

Raw Hide
Brushed

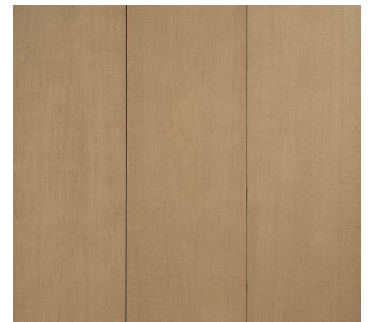

Raw Hide
Resawn

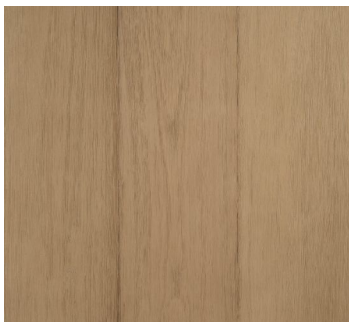

Raw Hide
Vertical Brushed

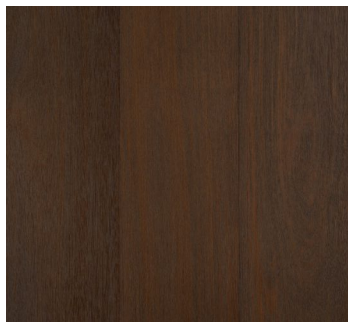

Saddle
Brushed

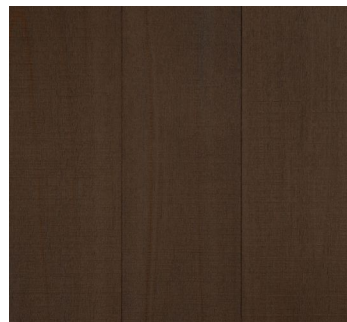

Saddle
Resawn

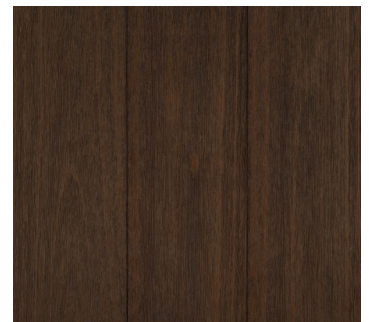

Saddle
Vertical Brushed

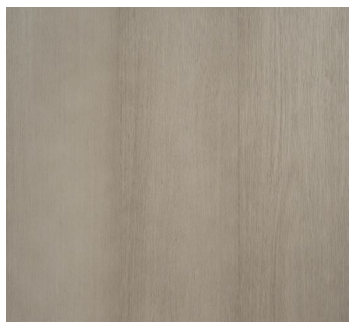

Sea Drift
Brushed

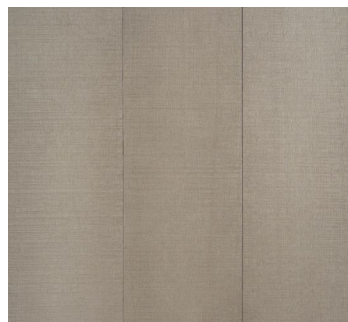

Sea Drift
Resawn

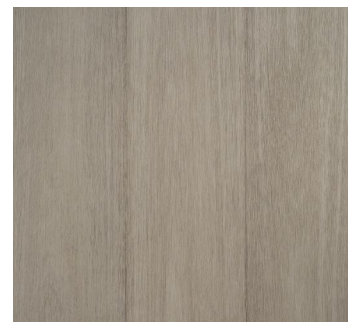

Sea Drift
Vertical Brushed

Sustainable Performance

Select Grandis represents a new generation of sustainable hardwoods, combining the aesthetic appeal of traditional species with rapid renewability. This species reaches maturity in a fraction of the time required by conventional hardwoods, making it an environmentally responsible choice without compromising on beauty or performance. Its natural durability and rich coloration have made it increasingly popular in high-end residential and commercial projects seeking both visual impact and ecological integrity.

Specifications

Widths	Lengths	Thickness	Grade
1×6 (5½" Face)	6'-16'	¾"	Clear Mixed Grain
Moisture Content	Milling	Colors	Textures
Kiln Dried to 10-12%	B2B T&G Shiplap	Available in Pre- Formulated and Custom Colors	Brushed Vertical Brushed Resawn

Clear Mixed Grain

Clear Mixed Grain Select Grandis combines the visual interest of varied grain patterns with the clarity of premium-grade hardwood. This grade features minimal defects while showcasing the natural diversity of grain orientation, creating dynamic character that adds depth to paneling and siding applications. The rich, warm tones of the base material are enhanced by the interplay of flat and vertical grain patterns, while the hardwood density ensures superior dimensional stability and durability in both residential and commercial projects.

Standard Milling Profiles

Hewn's Select Grandis is sold as 1×6 material. All of our Select Grandis is milled to your requested specifications in-house, allowing for the highest level of oversight throughout the entire production process. Our most common profiles are shown below.

Hewn has the capability to create custom milling knives in-house. For more information on custom milling options, please contact one of our sales representatives.

Square Edge

Select Grandis 1x6 (3/4" X 5-1/2") Square Edge with Eased Edges

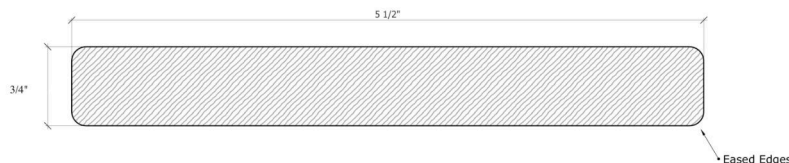

T&G Milling Profiles

Select Grandis 1x6 (3/4" x 5") T&G Tight 1/4" Tongue

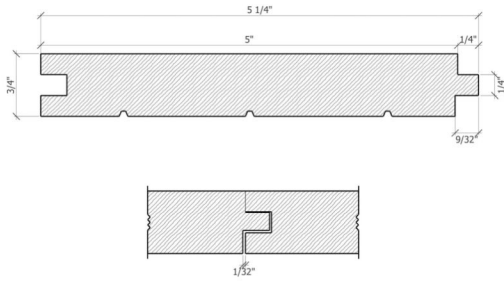

Select Grandis 1x6 (3/4" x 5") T&G 1/16" Finline 1/4" Tongue

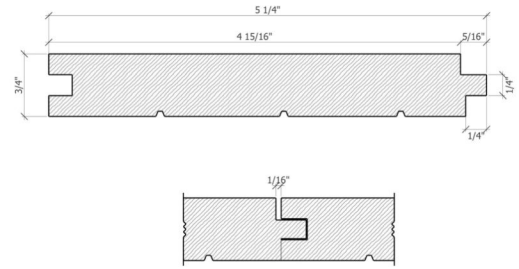

Select Grandis 1x6 (3/4" x 5") T&G 1/8" Finline 1/4" Tongue

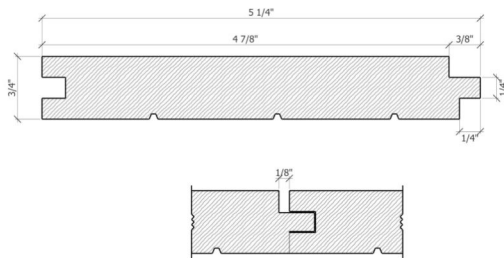

Select Grandis 1x6 (3/4" x 5") T&G 3/16" Finline 1/4" Tongue

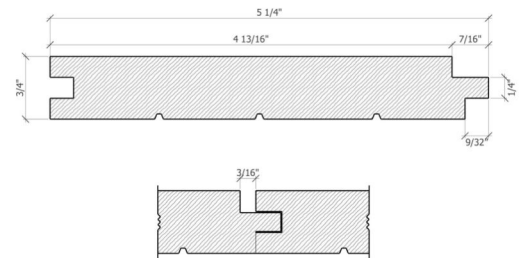

Select Grandis 1x6 (3/4" x 5") T&G 1/4" Finline 1/4" Tongue

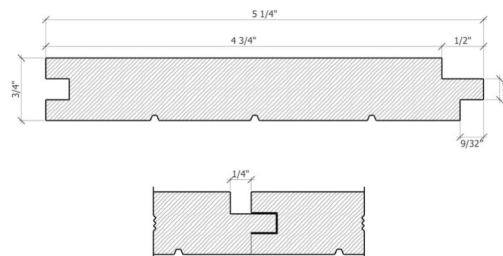

Shiplap Profiles

Select Grandis 1x6 (3/4" x 4-3/4") Shiplap Tight

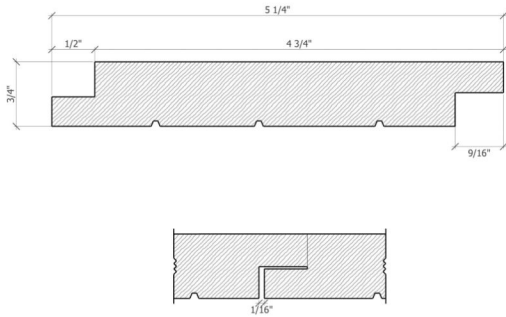

Select Grandis 1x6 (3/4" x 4-3/4") Shiplap 1/16" Gap

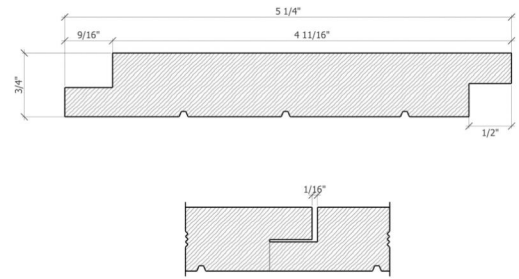

Select Grandis 1x6 (3/4" x 4-3/4") Shiplap 1/8" Gap

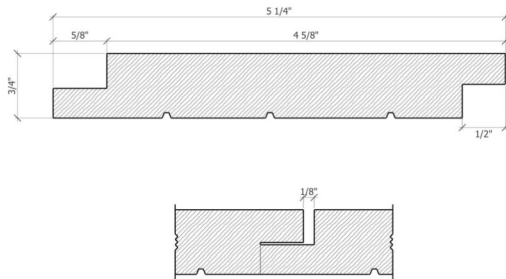

Select Grandis 1x6 (3/4" x 4-3/4") Shiplap 3/16" Gap

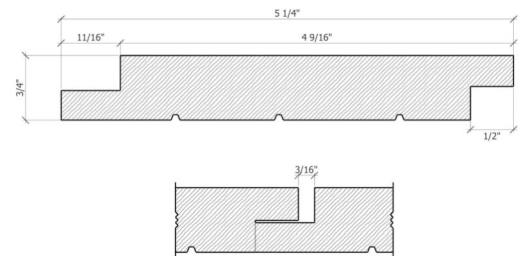

Select Grandis 1x6 (3/4" x 4-3/4") Shiplap 1/4" Gap

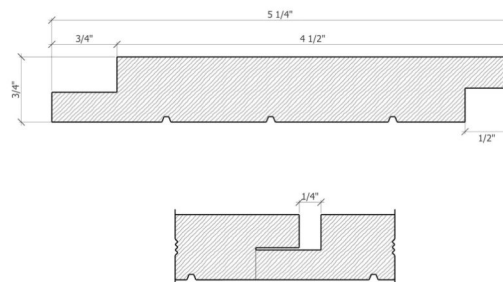

Nova Rainscreen Siding System

Select Grandis 1x6 Nova Clip 3/32" Gap

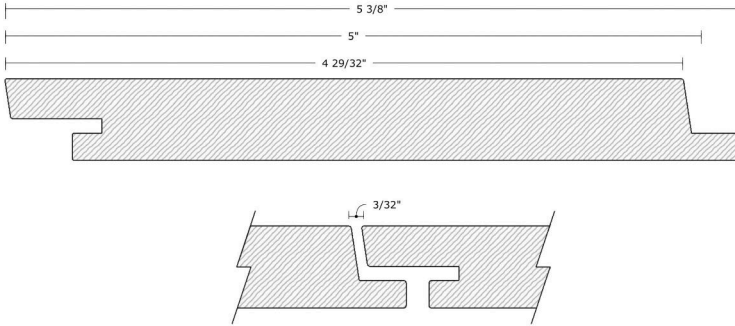

Select Grandis 1x6 Nova Clip 1/4" Gap

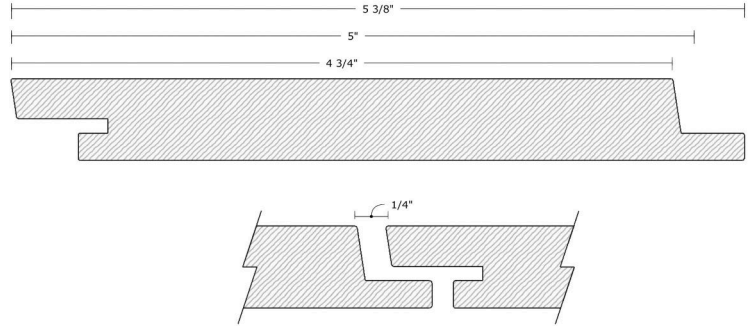

Select Grandis 1x6 Nova Clip 1/2" Gap

