



In this document:

- Ventilated Siding System
- Horizontal Siding
- Vertical and Diagonal Siding
- Handling and Machining
- Coating
- Fire Behavior
- Wood Information Guide



Ventilated Horizontal Siding System

A ventilated siding system is characterized by continuous ventilation behind the siding which ensures rain water and condensation behind the siding removed and for insulation to retain its effectiveness.

Joints

Accoya® is very dimensionally stable. This stability allows for siding boards to be butt jointed. However, spacing of 1/8" is often appropriate to allow for tolerance in cutting and installation on site and for drainage of water away from end grains, reducing risk of staining.

When joints are left open:

- Use a UV resistant breather membrane
- Protect furring with a suitable weather resistant joint tape
- Insert vermin mesh (typically for a joint > 13/32")

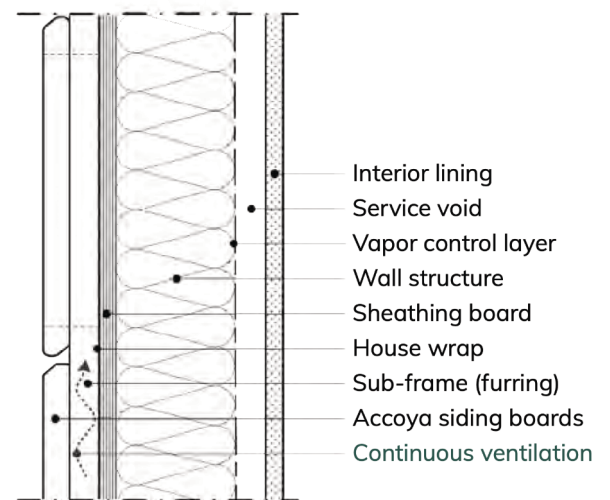

Ventilated Siding System

Important Design Considerations

The recommended cavity depth depends on the annual rainfall at location:

- 1/4" minimum in areas with an average annual rainfall of less than 20"
- 3/8" minimum in areas with an average annual rainfall of 20" to 60"
- 1/2" minimum in areas with an average annual rainfall of more than 60"
- 1/2" minimum also applies to all coastal areas (CZ50) and sites prone to heavy wind-driven rain
- 3/4" cavity may be used to allow for possible field-installation tolerances

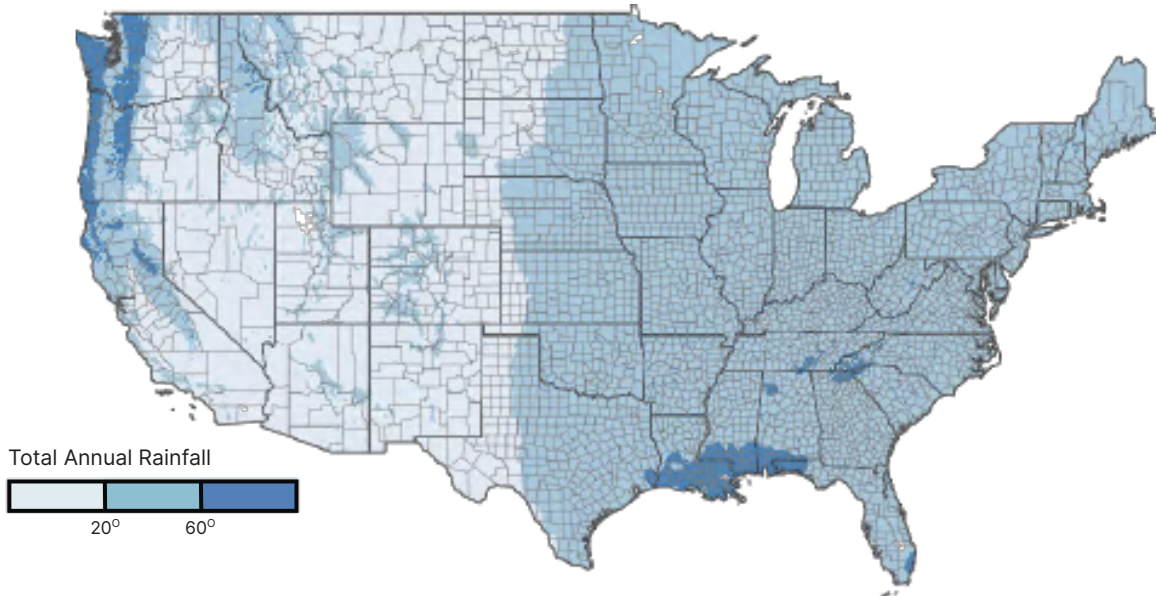

The map above illustrates the distribution of these rainfall areas. For accurate data in your region, please check www.ncei.noaa.gov/access/us-climate-normals/ (choose 'Annual/Seasonal' and '2006-2020').

Further design recommendations:

- Allow for sufficient ventilation in - and outlets at top/bottom (at least 1/32 in2 per ft2 siding)
- Use screening to prevent vermin intrusion
- Design for furring strips, flashings and weeps to prevent water intrusion
- If necessary, use additional outdoor caulks or sealants around windows and doors
- Trim:
 - extending down to a roof or deck requires a gap of at least 2" to avoid wicking
 - should be at least 6" above grade
- Do not fit boards flush to masonry or brickwork; leave a 1/4" gap to avoid trapped water
- Avoid installing siding in the 'splash zone' (between ground level and 8" to 10") because of a staining risk and reduction of the coating service life
- Applying a gravel section below the siding is recommended
- Consider increasing the speed of installing Accoya siding boards by milling a crusher bead into shiplap or tongue and groove profile

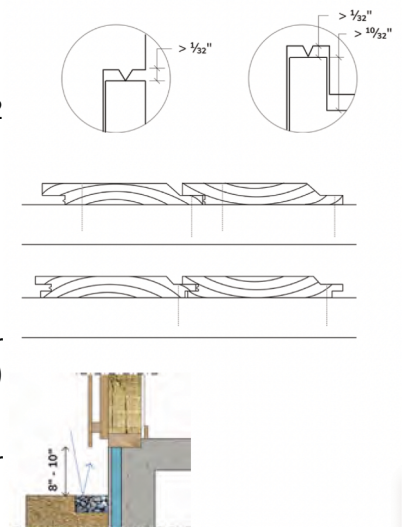

General Requirements Sub-Frame

- Minimum furring dimensions 1½" x 1½" unless fully supported by a structural substrate that is sufficiently thick to hold the required fastener length
- Maximum sub-frame distance (on center):
 - 24" when applied over wood based sheathing
 - 16" if installed without sheathing
- Use material of at least durability class 1 or 2
- Be aware of the risk of staining Accoya boards when using pressure treated or wood species prone to bleeding; in case of a risk of leaching, apply a barrier between the sub-frame battens and the Accoya siding boards, for example butyl tape or Protectowrap joist tape™
- Board ends should be supported by furring, which may incidentally be short pieces of extra furring in between or added sideways to the main furring. Conditions for unsupported joints, away from furring, are:
 - Maximum furring distance on center is 24"
 - Board profile is tongue-and-groove only, with a thickness of at least ¾"
 - Siding is located in wind zone I, OR fixed with at least 2 fasteners on the closest furring strips to the joint
 - Adjacent top + bottom boards are to be continuous over next 2 furring strips

Horizontal Siding

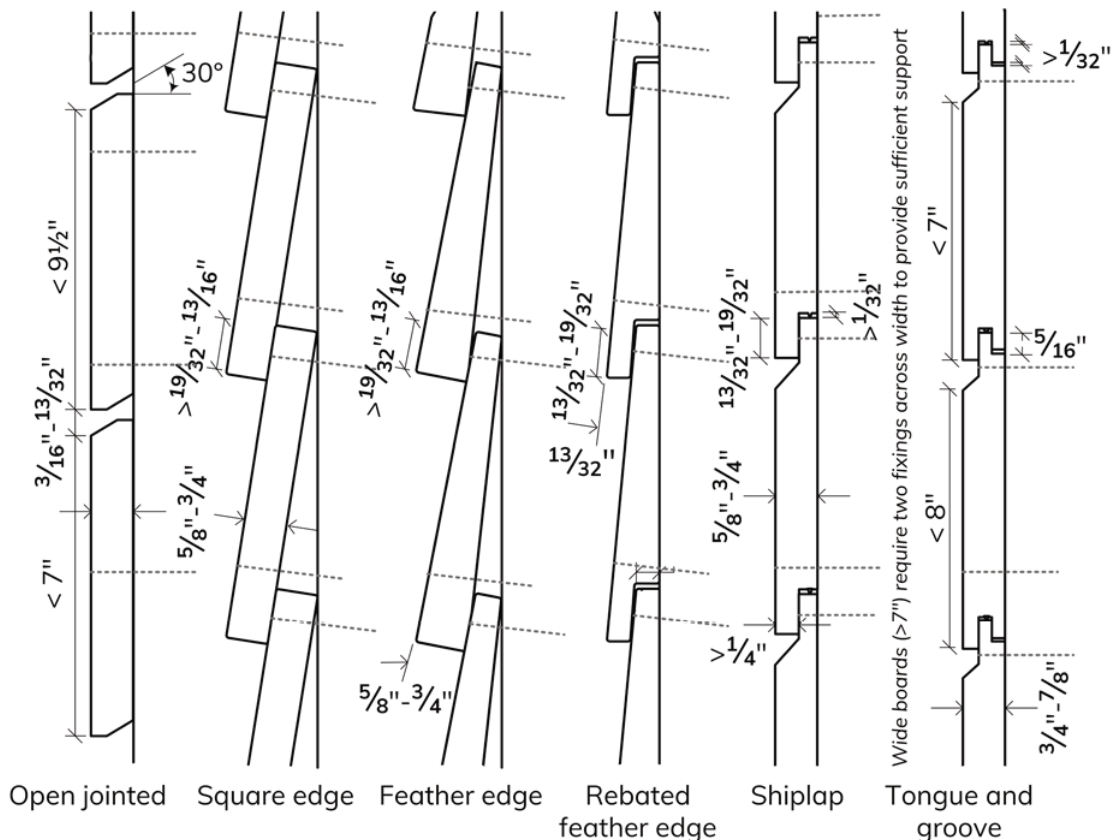

Vertical and Diagonal Siding

Visible Fastening

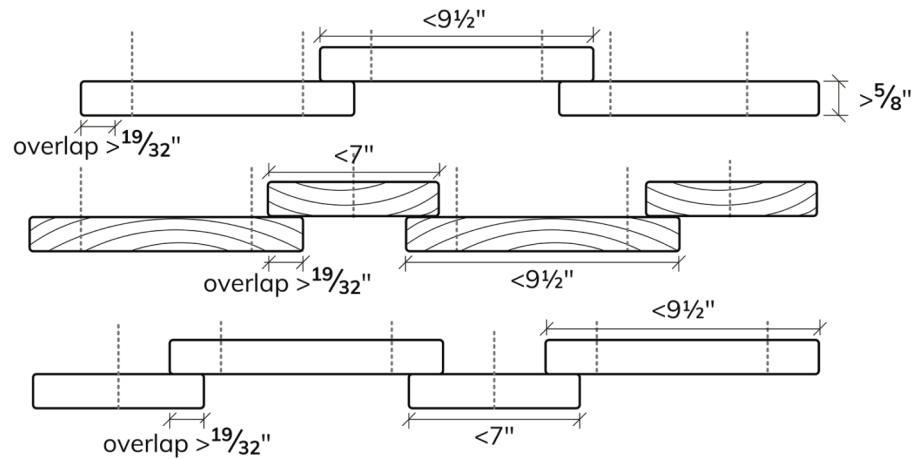

- Fixing used to install the top board must never pass through the underside board
- Chamfering board ends to shed water outward is recommended
- Wide boards (>7") require two fixings across width to provide sufficient support

Hidden Fastening

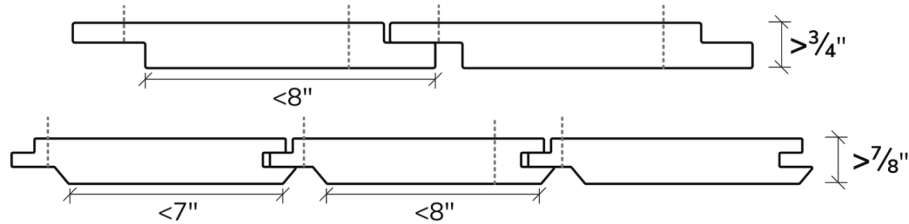

Fasteners

- Use ring shank or other improved nails
- Stainless steel 304 or 316 strongly recommended
- Holes pre-drilled:
 - To minimize the risk of boards splitting, it is recommended to pre-drill holes to 1/32" less than nail diameter or to 80% of screw shank diameter. This is especially important at board ends or for relatively thick fasteners.
- Point side penetration into the substructure:
 - 6 x d (ring shank)
 - $\geq 12 \times d$ (smooth)
- Check the screw-holding strength of furring chosen (if not wood)
 - Standard diameter for #6 and #8 nails is 0.12"
 - Penetration for a #6 or #8 nail needs to be at least 3/4" for ring shank and 1.5" for smooth

Do Not:

- Use staples or T-nails
- Drive the nail/screw heads into the board
- Use galvanized or zinc plated fasteners or accessories
- Install siding in direct contact with concrete, stucco, masonry, top soil, mulch patios and/or roofs

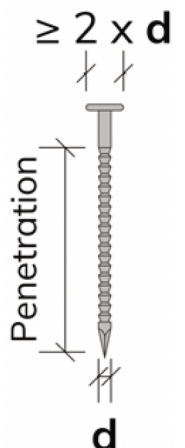

Placement

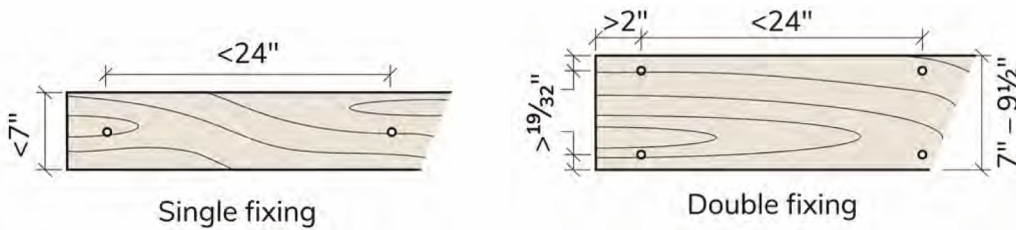

Vertical Siding Sub-Frame

Double furring

- Use 1/4" spacers or 1/4" vertical furring strips to support horizontal battens.
 - Note that as the horizontal furring is not fully supported, the minimum dimension is 1½" x 1½"
- Water penetration at the end grain of vertical furring should be avoided by applying a suitable sealer
- Horizontal furring should be chamfered at the top side, shedding water into the cavity (away from the siding boards)
- The lowest horizontal furring should slant inward at the bottom, creating a drip lip at the intersection with the counter battens

Single furring

- If a single sub-frame with only horizontal furring is used, additional ventilation measures need to be made by:
 - allowing for a cavity depth of at least 1/2" AND
 - making sufficient cut-outs in the furring OR
 - interrupting the furring at regular intervals, staggered relative to each other
- Single horizontal furring must be chamfered on the top edge to shed any water outwards (away from the structural wall)



Storage and Handling

- Store boards horizontally, in reasonably dry (well ventilated) conditions and lifted clear of the floor
- Center bearers on 30" max and use at least 3 bearers
- Cover the boards with a breathable barrier / "vapor-open" plastic
- Storage at the building site:
 - should be at least 4" above concrete flooring and 1" above ground
 - additional protection from rain with plastic sheets is recommended
 - sufficient ventilation underneath the sheets is required to prevent mould

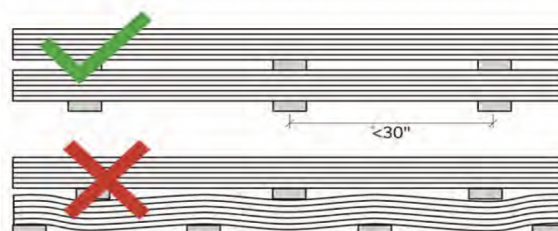

Transport

General

- Use conventional wood working equipment and tools Accoya can be compared generally with harder softwood species
- Use carbide-tipped tools or diamond tipped for high(er) volumes
- Make sure that knives are aligned and sharp
- Spindle rotation velocity of 12,000 – 6,000 rpm
- Feed speed 25 – 55 feet per minute
- Use rubber out-feed rollers

Sawing

- Standard techniques such as using backer boards can be used when very fine results are desired

Drilling

- Remove debris for deep drilling

Planing & profiling

- Accoya shavings are fine and may be electrostatically loaded; in case of impression problems, increase the rpm or use anti-friction lubricants

Bending

- Use techniques similar to other softwoods, e.g. kerfing
- *Note that Accoya is resistant to setting after steam bending -if left unrestrained by fixings after bending, it will naturally spring back to close to its original form*
- *Do not impregnate with ammonia to ease bending*

Sticker mark removal

The acetylation process can result in discoloration and sticker marks generally up to 1/8" in depth, occasionally deeper. Removal of this surface discoloration is not required when using opaque coatings. Discoloration and sticker marks will fade in time proportionate to the level of UV exposure.

For example, when producing a 3/4" thick siding board from 1" Accoya, it is recommended to set the bottom knife to remove 1/32" from the back side and remove remaining over thickness from the top side.

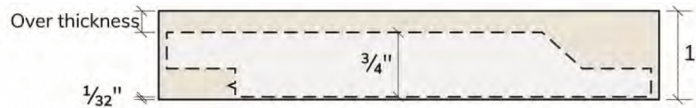

Sawing

The minimum recommended dimensions of the board sections for the various profiles are depicted on the previous page. Re-sawing or ripping Accoya boards can reveal stresses created during drying and processing. Ripping to create thinner boards is therefore not recommended with boards having an original thicknesses of more than 1 1/2" and should be approached cautiously in all instances. When using 5/4" rough sawn boards to produce —" siding, preferably use a thin kerf saw and design for square edge or overlap rather than rebated, or T&G profiles. Nevertheless, these boards will be more prone to damage and slightly more checking. Please note that for very thin boards the batten spacing may need to be reduced to 12" or less.

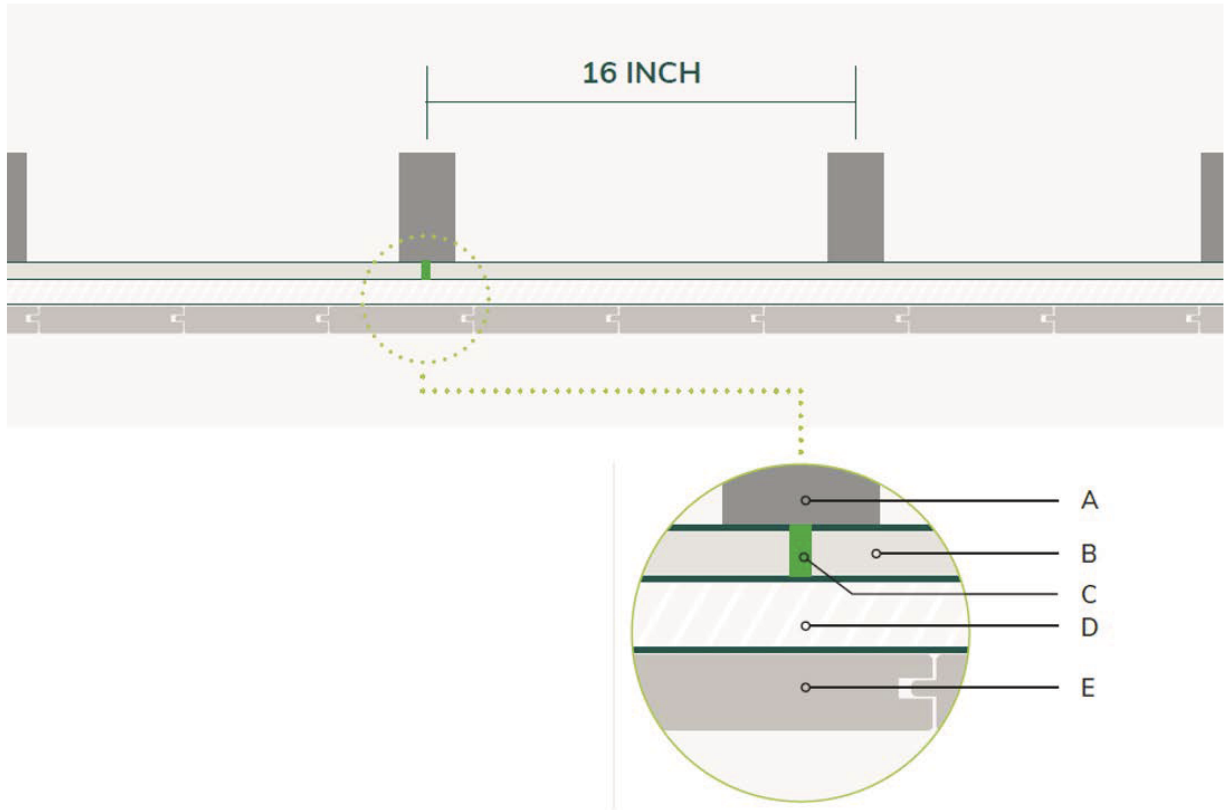

- A. Wall construction, $\geq 2 \times 4$ " lumber studs
- B. 5/8" DensGlass Gold sheathing or equivalent
- C. All DensGlass butt joints filled with fire resistant caulk
- D. Cavity depth is to be a minimum 3/8" for WUI compliance. A ventilated cavity is required to maintain the Accoya Warranty. Warranty required cavity depth ranges from 1/4" to 3/4" dependent on climate zone. Refer to map on p2
- E. 3/4" or 1" Accoya, T&G

Siding boards were selected at random, witnessed by third party auditor TPI from Accoya distributor in North Carolina. Fire-resistant caulk used for testing was 3M Fire Block Sealant FB 136. Testing was performed at ICC NTA, LLC, an accredited third-party agency headquartered in Nappanee, Indiana, and part of the International Code Council family of solutions.

Coating

General

- There is no technical need to finish Accoya siding boards
- Uncoated Accoya is susceptible to outdoor weathering, particularly in high rainfall areas
- Mold growth can be avoided by using a suitable outdoor primer addressing mold growth

Preparation

- The Accoya should be dry - moisture content <8%
- Surface must be clean, dry and free from dust and grease
- Finish the panels on all sides before mounting them
- Treat the ends of the boards with end-grain sealer
- For best results, any coating should best be applied industrially
- Round off corners with a radius of at least 1/8"

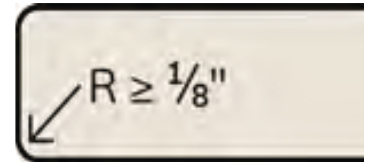

Changed Properties

- Due to the hydrophobic nature of Accoya, water-based stains may not penetrate as deep or form as thickly
- The small amount of residual acetic acid may disturb the flow coating process, which can be prevented by adding an alkaline buffer (always below a pH of 9)

End seal

All exposed end grain should be coated with an effective end seal

Rounded corners

All Accoya siding boards should be rounded with 1/8" radius corners

Factory coating

Factory application of coatings is recommended to achieve optimum performance

Dark translucent colors

Can provide longer maintenance intervals than lighter shades

Four sides coated

Siding boards should be coated on all 4 sides for superior performance

Longevity

Film forming coatings provide the longest maintenance intervals

Opaque coatings

A stain blocker is recommended

Avoiding discoloration

Discoloration can be avoided by using a high quality UV resistant coating

Fire Behavior

Flame spread test

Southwest Research Institute (SwRI) performed Flame Spread Tests and Smoke Developed Tests in accordance with the standard test method for surface burning characteristics of building materials NFPA 255 (ASTM E84, ANSI, UL723 & UBC 8-1).

The conclusion of the Flame Spread Test results is that Accoya wood can be classified within the range of standard timber species and achieves Class C in this US rating system.

Alternative design measures may be taken to achieve a sufficient fire resistance of a wooden façade siding. For example, a charred Accoya board finish can achieve Class B. As there are several proprietary charring processes available in the market each one needs to be evaluated on a case by case basis.

Accoya Siding WUI compliance

The fire performance of exterior siding materials is especially critical in Wildland-Urban Interface (WUI) zones, where wildfires pose a significant risk to homes and other structures.

The California Building Code (CBC), established by the State of California, outlines general requirements for building design and construction related to fire and life safety, structural safety, and accessibility. It specifically regulates materials, systems, and assemblies used for structural fire resistance and fire-rated construction separations to prevent the spread of fire and smoke within buildings and between structures.

Chapter 707A applies to building materials, systems, and assemblies used in the exterior design and construction of new buildings located within Wildland- Urban Interface (WUI) areas or in any Fire Hazard Severity Zone within State Responsibility Areas. The goal is to set minimum standards to resist the penetration of flames or embers from wildfires.

This section requires that exterior wall assemblies of permitted buildings be tested using the 10-minute direct flame contact exposure test outlined in ASTM E2707.

ICC NTA tested Accoya wood siding at its Bryan Test Lab in Bryan, TX and verified that it met the acceptance criteria for wall or ceiling finishes under ASTM E2707, which assesses fire penetration of exterior wall assemblies using direct flame exposure. The construction summary of the assembly is shown in the illustration below.